

The background of the cover page is a photograph of a solar farm. It shows rows of dark blue solar panels mounted on metal frames in a grassy field under a bright blue sky with some clouds. A large, semi-transparent red parallelogram is overlaid on the right side of the image, containing the title text.

Installation Manual for LONGi Solar PV Modules

Applicable Module Type			Certification Status	Module Structure	
	LR6-60-***M	LR6-72-***M	IEC、UL	single glass	
	LR6-60BK-***M	LR6-72BK-***M	IEC、UL	single glass	
	LR6-60HV-***M	LR6-72HV-***M	IEC、UL	single glass	
	LR6-60PB-***M	LR6-72PB-***M	IEC、UL	single glass	
	LR6-60PE-***M	LR6-72PE-***M	IEC、UL	single glass	
	LR6-60PH-***M	LR6-72PH-***M	IEC、UL	single glass	
	LR6-60MP-***M	LR6-72MP-***M	IEC	single glass	
	LR6-60MPH-***M	LR6-72MPH-***M	IEC	single glass	
	LR6-60HPH-***M	LR6-72HPH-***M	IEC、UL	single glass	
	LR6-60HPH-***MC	LR6-72HPH-***MC	IEC、UL	single glass	
	LR6-60HPB-***M	/	IEC、UL	single glass	
	LR6-60OPH-***M	LR6-72OPH-***M	IEC	single glass	
	LR6-60DG-***M	LR6-72DG-***M	IEC、UL	double glass	
	LR6-60PD-***M	LR6-72PD-***M	IEC、UL	double glass	
	LR6-60HPD-***M	LR6-72HPD-***M	IEC、UL	double glass	
	LR6-60HIH-***M	LR6-72HIH-***M	IEC、UL	single glass	
	LR6-60HIB-***M	/	IEC、UL	single glass	
Monofacial Module	LR4-50HPH-***M	/	IEC、UL	single glass	
	LR4-60HPH-***M	LR4-72HPH-***M	IEC、UL	single glass	
	LR4-60HPB-***M	/	IEC、UL	single glass	
	LR4-60HIH-***M	LR4-72HIH-***M	IEC、UL	single glass	
	LR4-60HIB-***M	/	IEC、UL	single glass	
	LR4-66HPH-***M	/	IEC、UL	single glass	
	LR4-66HP-***M	/	IEC、UL	single glass	
	LR4-66HIH-***M	/	IEC、UL	single glass	
	LR5-54HPH-***M	/	IEC、UL	single glass	
	LR5-54HPB-***M	/	IEC、UL	single glass	
	LR5-54HIH-***M	/	IEC、UL	single glass	
	LR5-54HIB-***M	/	IEC、UL	single glass	
	LR5-54HNB-***M	/	IEC、UL	single glass	
	LR5-54HTH-***M	/	IEC、UL	single glass	
	LR5-54HTB-***M	/	IEC、UL	single glass	
	LR5-66HPH-***M	LR5-72HPH-***M	IEC、UL	single glass	
	LR5-66HIH-***M	LR5-72HIH-***M	IEC、UL	single glass	
	/	LR5-72HTH-***M	IEC、UL	single glass	
	Bifacial Module	LR4-60HBD-***M	LR4-72HBD-***M	IEC、UL	double glass
		LR4-60HIBD-***M	LR4-72HIBD-***M	IEC、UL	double glass
LR5-54HIBD-***M		LR5-72HBD-***M	IEC、UL	double glass	
LR5-54HIBB-***M		LR5-72HIBD-***M	IEC、UL	double glass	
LR5-54HABD-***M		LR5-72HND-***M	IEC、UL	double glass	
LR5-54HABB-***M		LR5-72HTD-***M	IEC、UL	double glass	
LR5-66HBD-***M		/	IEC、UL	double glass	
LR5-66HIBD-***M		/	IEC、UL	double glass	

*The information of frameless modules and LR6 types are shown in the V15 version of LONGi PV Module Installation Manual.

- This manual elaborates on installation and safety use information for PV power generating modules (hereinafter referred to as module) of LONGi Solar Technology Co., Ltd. (hereinafter referred to as LONGi). Please abide by all safety precautions in this guide and local regulations.
- Installation of modules requires professional skills and knowledge and is to be carried out by qualified personnel. Please read this manual carefully before installing and using this module. Installation personnel shall get familiar with mechanical and electrical requirements of this system. Please keep this manual properly as reference for future maintenance or upkeep or for sales and treatment of modules.
- If you have any doubts, please contact LONGi customer service personnel for further interpretation.



Safety Note

Contents

3	1 / Introduction
3	2 / Laws and Regulation
4	3 / General Information
4	3.1 Modules Identification
6	3.2 Junction box style and wiring method
8	3.3 Regular Safety
9	3.4 Electrical Performance Safety
9	3.5 Operation Safety
10	3.6 Fire Safety
11	4 / Installation Conditions
11	4.1 Installation Site and Working Environment
12	4.2 Selection of Tilt Angles
13	5 / Mechanical Installation
13	5.1 Regular Requirements
13	5.2 Monofacial assembly mechanical installation
14	5.2.1 Bolts Mounting
14	5.2.2 Clamp Mounting
15	5.2.3 Installation and Mechanical Load of Monofacial Module
17	5.3 Bifacial module Mechanical Installation
17	5.3.1 Bolts Mounting
18	5.3.2 Clamps Installation
19	5.3.3 Installation and Mechanical Load of Bifacial Module
23	6 / Electrical installation
23	6.1 Electrical Performance
23	6.2 Cables and Wiring
24	6.3 Connector
24	6.4 Bypass diode
24	6.5 PID Protection and Inverter Compatibility
25	7 / Grounding
26	8 / Operation and maintenance
26	8.1 Cleaning
27	8.2 Module Appearance Inspection
27	8.3 Inspection of Connectors and Cables
27	9 Release and execution

1 Introduction

Electrical and mechanical installation information will be introduced in this installation manual, so please read and understand the information before installing LONGi modules. In addition, this manual also contains some safety information that you shall be familiar with. All contents in this manual are intellectual properties of LONGi which originates from long term of technical exploration and experience accumulation of LONGi.

This installation manual does not entail any explicit or implicit quality warranty and does not stipulate on compensation schemes for losses, module damages or other costs caused by or related to module installation, operation, utilization and maintenance process. LONGi will not take any responsibility if patent rights or the third party rights are infringed by use of modules. LONGi reserves the rights for modifying product manual or installation manual without noticing in advance. It is recommended to visit our website regularly at www.longi.com for the latest version of this installation manual.

If customers fail to install modules as per requirements set forth in this manual, the limited warranty provided for customers will be invalid. In addition, suggestions in this manual are to improve safety of module installation, which are tested and proved by practices. Please provide this manual to PV system users for reference and inform the advises on operation, maintenance requirements etc.

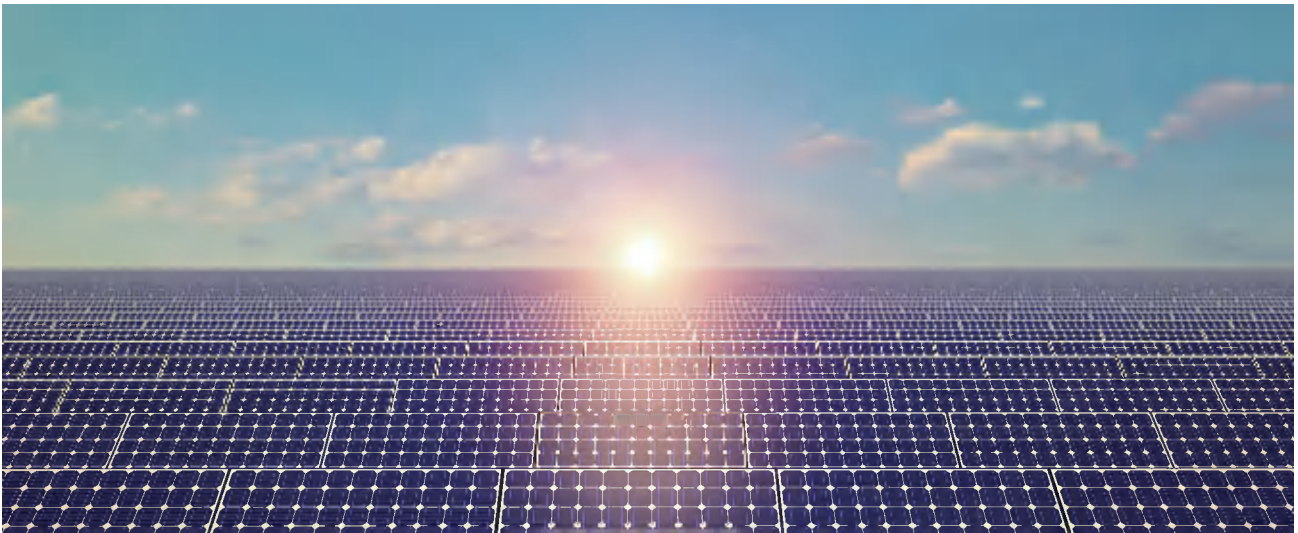

2 Laws and Regulation

The mechanical and electrical installation of photovoltaic modules shall be in accordance with applicable regulations, including electrical law, construction law and electrical connection requirements. These regulations vary from sites to sites, for example, building roof installation, vehicle applications, etc. Requirements may also vary depending on the installed system voltage, DC or AC. Please contact local authorities for specific terms.

3 General Information

3.1 Modules identification

Three labels on the module contain the information below:

1. Nameplate: product type, rated power, rated current, rated voltage, open circuit voltage, short circuit current under testing conditions, certification indicator, maximum system voltage, etc.
2. Current classification label: Rated working current.(H indicates High, M indicates Medium, L indicates Low)
3. Serial Number label: A unique serial number which is laminated inside the module permanently which can be found in the front of the module. There is another same serial number beside the module nameplate.

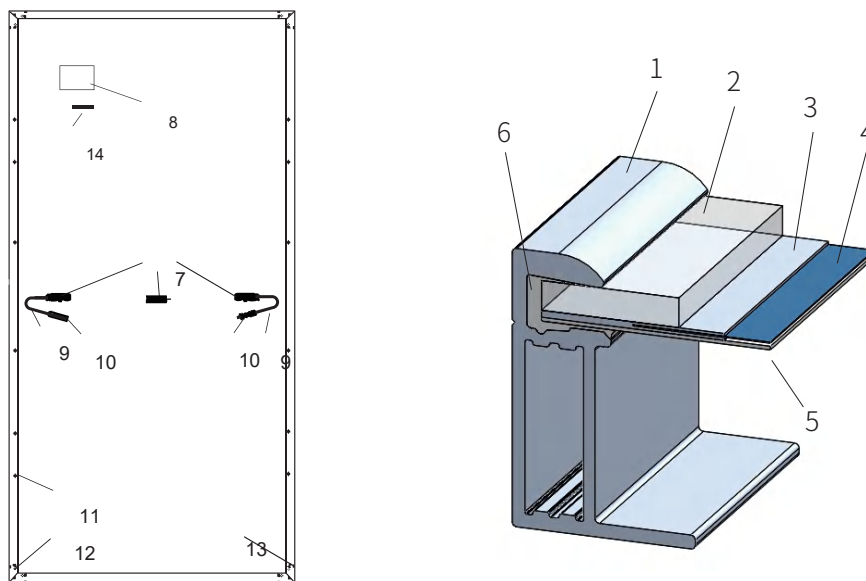

1	Frame	2	Glass	3	EVA	4	Solar Cell
5	Backsheet	6	Silica Gel	7	Junction Box	8	Name Plate
9	Cable	10	Connector	11	Mounting Hole	12	Grounding Hole
13	Drain Hole	14	Bar Code				

Figure 1 Typical Mechanical Drawing of Mono-facial Modules

(Please refer to section 3.2 for the location of the junction box. The specific version is subject to the corresponding specification.)



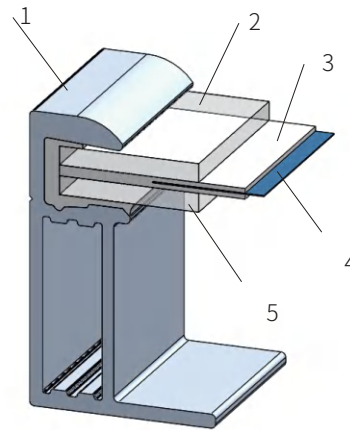
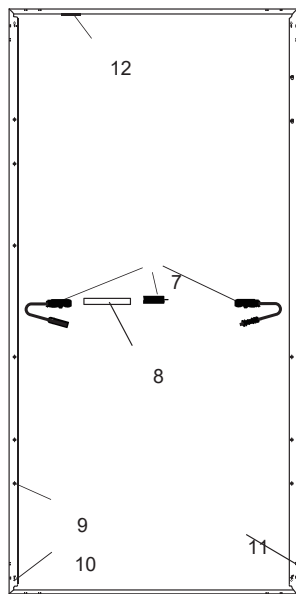

Bifacial Modules (With Frame)

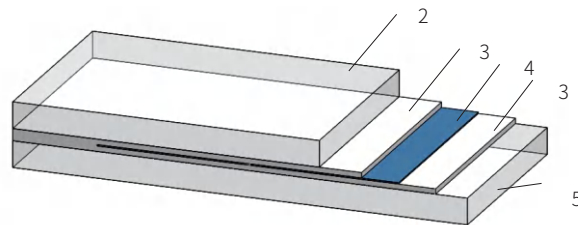

Bifacial Modules (Frameless)

1 Frame	2 Front Glass	3 EVA/POE	4 Solar Cell
5 Back Glass	6 Sealant	7 Junction Box	8 Name Plate
9 Mounting Holes	10 Grounding Holes	11 Drain Holes	12 Bar Code

Figure 2 Typical Modules Mechanical Drawing

(Please refer to section 3.2 for the location of the junction box. The specific version is subject to the corresponding specification.)



3.2 Junction box style and wiring method

Junction Box Location Icon

Recommended Wiring Method

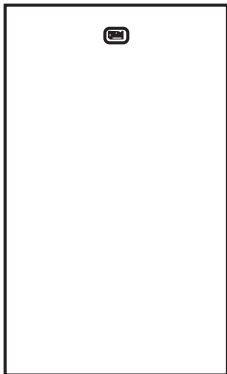

Vertical Installation: Standard Cable Length
(Note: One end of the single row needs to be extended.)

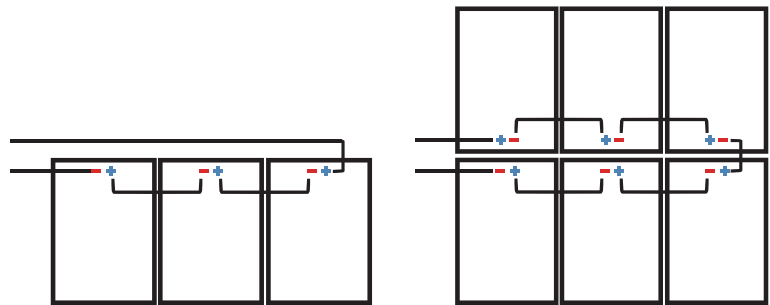

Horizontal Installation: Standard Cable Length

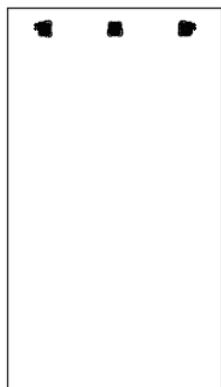
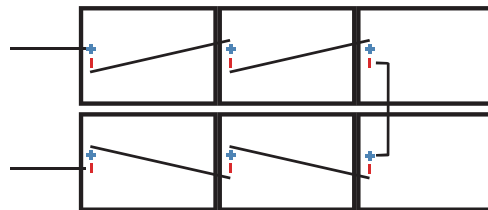

Vertical Installation: Standard Cable Length
(Note: One end of the single row needs to be extended.)

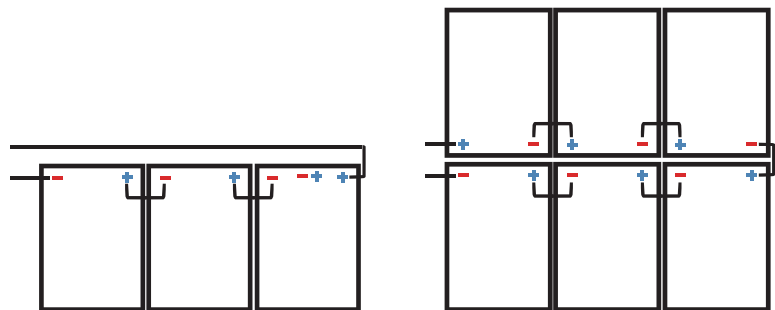

Horizontal Installation: 60 type PV module cable length $\geq 1.2\text{m}$, 72 type PV module cable length $\geq 1.4\text{m}$

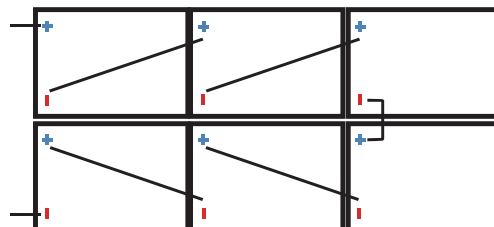

Junction Box Location Icon

Recommended Wiring Method

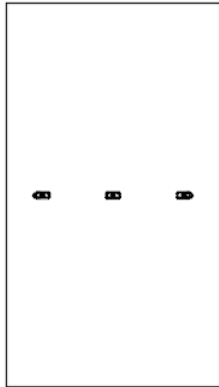

Vertical Installation: Standard Cable length:

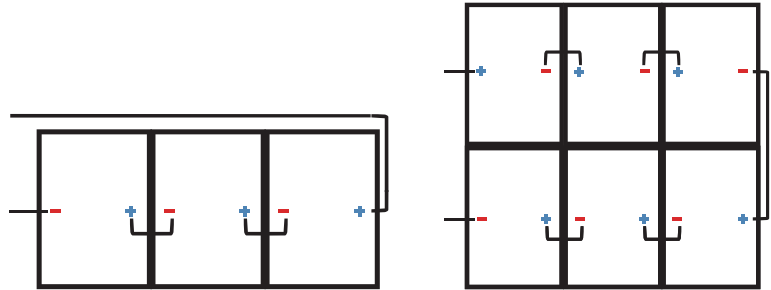

Note: The extra extended cable is required for connection at the turn-back corner of wiring as shown below.

Horizontal Installation:

60 type PV module cable length $\geq 1.2\text{m}$, 72 type PV module cable length $\geq 1.4\text{m}$, 78 type PV module cable length $\geq 1.5\text{m}$

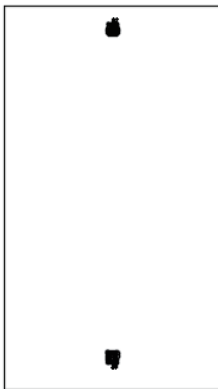
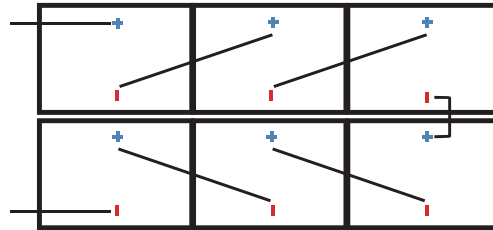

Vertical Installation:

Method 1: Standard cable length

Method 2: Single component cable length $\geq 1.2\text{m}$

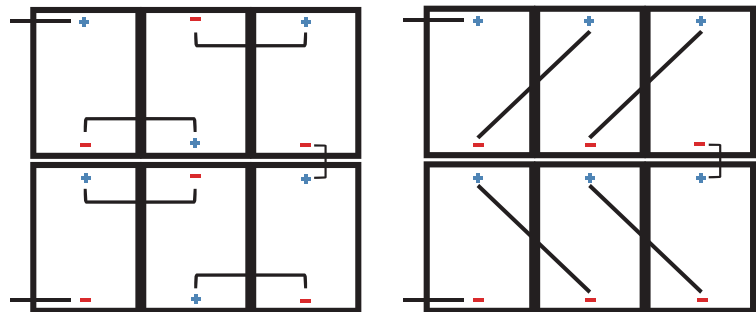

Horizontal Installation: Standard cable length

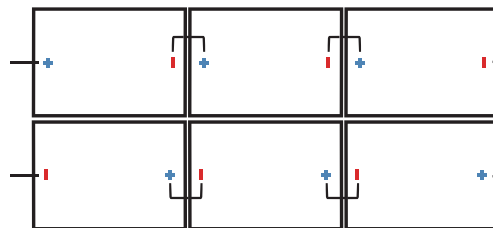

Junction Box Location Icon	Recommended Wiring Method
	<p data-bbox="651 275 1005 332">Vertical installation: Method 1: Standard cable length</p>  <p data-bbox="1082 303 1458 360">Method 2: Single component cable length $\geq 1.2\text{m}$</p>  <hr/> <p data-bbox="651 778 1133 806">Horizontal Installation: Standard cable length</p> 

Figure 3 Junction Box Style and Wiring Method



3.3 Regular Safety

The application level of LONGi Solar module is Class II, which can be used in systems operating at $> 50\text{ V DC}$ or $>240\text{ W}$, where general contact access is anticipated;

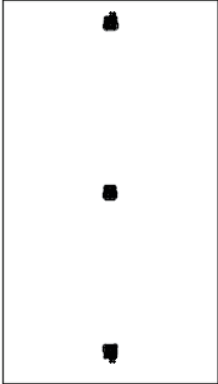
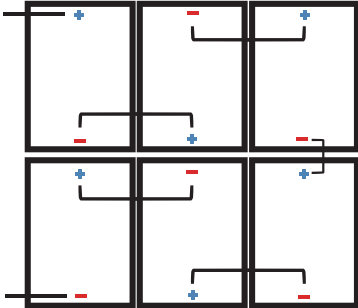
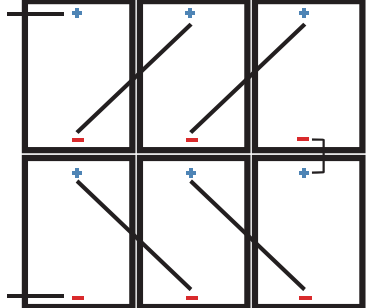
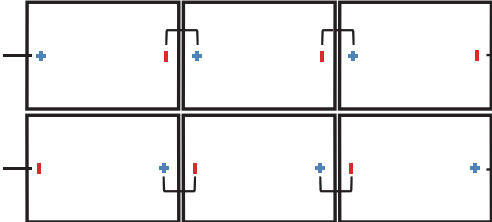
When the modules are for rooftop application, it is necessary to take the overall fire rating of the finished structure as well as operation and maintenance into account. The roofing PV system shall be installed after being evaluated by construction experts or engineers and with official analysis results for the entire structure. It shall be proved capable of supporting extra weight of system racking structures and PV modules.

For your safety, please do not work on the roof without PPE(Personal Protective Equipment) which include but not limited

to fall protection, ladder or stair and personal protective measures.

For your safety, please do not install or handle modules in unsafe conditions including but not limited to strong wind or gust, damp or sandy roofs.



PV modules can produce DC current under sunlight. Any contact of exposed metal at module's wiring parts may result in electrical shock or burn. Any contact of 30V or larger DC Voltage can be fatal.

In case of no connected load or external circuits, modules can still produce voltage. Please use insulation tools and wear rubber gloves when operating modules in the sunlight.

No switch is on the PV modules. Operating of PV modules can only be stopped when they are kept from sunlight or covered by hard board or UV-proof materials or when the angle of the modules facing sun are placed on smooth and flat surfaces.

To avoid electric arc or electric shock hazards, please do not break down electric connection in loaded conditions. Incorrect connections will also lead to electric arc or shock. Keep connectors dry and clean and make sure that they are in good operating condition. Do not insert other metals into the connectors or carry out electric connection by whatever means. Snow, water or other reflective medium in surrounding environments that intensify light re-reflection will increase output current and power. And module voltage and power will increase under low temperature condition.

If module glass or other sealing materials are damaged, please wear PPE(personal protective equipment) and then isolate modules from the circuit.

Do not operate when modules are wet unless you wear PPE(personal protective equipment). Please follow the cleaning requirements in this manual when cleaning modules.

Do not contact connectors with the following chemicals: Gasoline, White Flower oil, woodlock oil, Mold temperature oil, Engine oil (such as KV46), Grease (such as Molykote EM-50L), Lubricating oil, Rust-proof oil, Stamping oil, Diesel, Cooking oil, Acetone, alcohol, essential balm, Bone-setting liquid, Banana oil, release agent (such as Pelicoat S-6), adhesive and potting materials capable of generating oxime gas (such as KE200, CX-200, chemlok), TBP, cleaning agent etc.



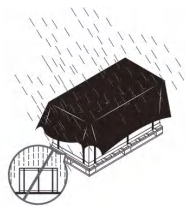

- Open modules outer package when installation.
- Do not damage the package and do not drop packaged modules on the ground.
- Do not exceed the indicated maximum layer limit on the packaging carton when piling modules up.
- Put packaging carton in the ventilated, water-proof and dry places before unpacking modules.
- Follow unpacking instructions when Opening packaging carton.
- Carrying modules with the junction box or wires are strictly forbidden.
- Do not stand or walk on modules.
- To avoid glass to be damaged, heavy objects are not allowed on modules.
- Be careful when placing modules at corners in particular.
- Do not try to dismantle the module or remove nameplate or parts of modules.
- Do not paint or apply any other adhesive on modules.
- Do not damage or scratch backsheet of modules.
- Do not drill holes on the frame of module, which may reduce frame loading capacity and lead to frame corrosion and invalidation of the limited warranty provided for customers
- Do not scratch anodic coating of aluminum alloy frame except for grounding connection. Scratch may lead to frame corrosion and reduce frame loading capacity and long-term reliability.
- Do not repair problematic modules on your own.



3.6 Fire Safety

Please refer to local laws and regulations before installing modules and abide by requirements on building fire protection.

According to the corresponding certification standards, the fire rating of LONGi Mono-facial modules is UL type 1r2 or IEC Class C, the fire rating of LONGi bifacial modules is UL type 29 or IEC Class C.

The roof should be coated by a layer of fireproof materials with suitable fire protection rating for roofing installation and make sure that the back sheet and the mounting surface are fully ventilated.

Different roof structures and installation modes will affect fireproof performance of buildings. Improper installation may lead to the risk of fire.

To guarantee roof fire rating, the distance between module frame and roof surface must be $\geq 10\text{cm}$. (0.39 inch)

Adopt proper module accessories such as fuse, circuit breaker and grounding connector according to local regulations.

Please do not apply modules in where exposed inflammable gases are nearby.

4 Installation Conditions

4.1 Installation Site and Working Environment

- The modules cannot be used in space
- Do not manually focus sunlight with mirrors or magnifying glass onto modules.
- LONGi modules shall be installed on proper buildings or other appropriate places (such as ground, garage, building outer wall, roof, PV tracking system) but shall not be installed on any vehicles.
- Do not install modules at places that are possible to be flooded.
- LONGi suggests that modules be installed in the working environment with the temperature of -40°C to 40°C of which is the monthly average highest and lowest temperature of the installation sites. The extreme working environment temperature for modules is -40°C to 85°C .
- Make sure that installed modules do not suffer wind or snow pressure that exceeds the permissible maximum load limit.
- Modules shall be installed in places free from shadows throughout the year. Make sure there are no light-blocking obstacles in the installation sites.
- Carry out lightning protection for modules installed in places with frequent lightning and thunder.
- Do not install modules in places with possible inflammable gases.
- Modules cannot be used in environments with too much hails, snows, flue gas, air pollution and soot or in places with strong corrosive substances such as salt, salt mist, saline, active chemical steam, acid rain, or other substances corroding modules, affecting modules' safety or performance.
- Please take protective measures to ensure reliable and safe installation of modules in severe environments such as heavy snow, cold and strong wind or islands close to water and salt mist or deserts.
- LONGi modules passed the IEC61701 salt spray corrosion test, but the corrosion may still occur on where the modules frame is connected to the bracket or where the grounding is connected. In case LONGi modules can be installed $\geq 50\text{m}$ away from the ocean side, and related parts and components should be protected with anti-corrosion measures.



4.2 Selection of Tilt Angles

Tilt angle of PV modules refer to the included angle between module surface and horizontal ground. The module will obtain the maximum power output when directly facing the sunlight.

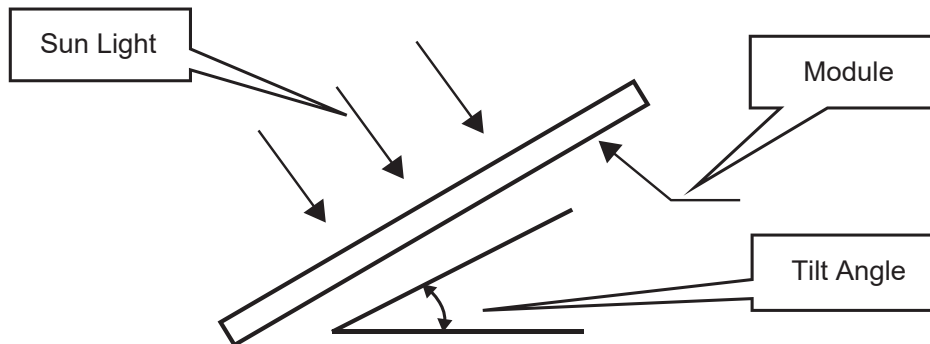

Modules are preferred to be south-facing in the north hemisphere and north-facing in the south hemisphere. Please refer to standard modules installation guideline or suggestions from experienced PV module installer, for the specific installation angle.

LONGi suggests that tilt angle of module installation be no less than 10° , so module surface dust can be washed away easily by rainfall and frequency of cleaning can be reduced. And it is easy for accumulated water to flow away physically and avoid water mark on the glass surface which may further affect module appearance and performance.

LONGi modules connected in string should be installed with the same orientation and tilt angle. Different module orientation and tilt angle may result in different levels of solar irradiation and also power generation. In order to achieve the maximum annual generating capacity, the optimal orientation and inclination of PV modules in the installed area should be selected to ensure that sunlight can still reach to modules even on the shortest day of the year.

If LONGi modules are used in off-grid System, the tilt angle should be calculated based on seasons and irradiation to maximize the output power. If the modules output power meets the acquired load under the period of the worst irradiation in the year, the modules should be able to meet the load of the whole year. If the LONGi modules are used in grid-connected system, the tilt angle should be calculated based on the principle to maximize the yearly output power.



5 Mechanical Installation

5.1 Regular Requirements

- Make sure that installation method and mounting structure are solid enough to meet the expected load-bearing requirement, which is requisite assurance from PV system installer. Installation bracket system shall be tested and inspected by the third party testing institution with static mechanical analysis capacity in accordance with local national standards or international standards.
- Mounting structure shall be made from durable, corrosion resistant, UV-proof materials.
- Modules shall be fixed on the bracket solidly.
- In regions with heavy snowfall in winter, adjust the height of the mounting system so that the lower edge of the module is not covered by snow. In addition, ensure the lower part of module is not in the shadow of plants, trees or damaged by flying sand and stone.
- If modules are installed on brackets parallel to the roof or wall, the minimum gap between the module frame and the roof/wall shall be 10cm which is good for air circulation to achieve better performance of module. Make sure the building is suitable for installation before installing modules on roof. Moreover, seal properly to prevent leakage.
- The module frames can appear thermal expansion and cold contraction. So the minimum distance between two adjoining modules shall be no less than 10 mm (0.39 inch).
- Make sure that backsheet of modules will not be in contact with bracket or building structures that can pierce into the inside of the modules, especially when the module surface is imposed by pressure.
- Maximum static load of the PV module is downforce 5400pa and uplift force 2400pa, which can vary from different mounting methods of the modules (please refer to the following installation guidance), the described load in this manual is for the test load.
- Note: on the basis of IEC61215 - 2016 installation requirements, when computing the corresponding maximum design load, a safety factor of 1.5 need to be considered in compliance with the local laws or regulations.
- Modules can be installed horizontally or vertically. When installing the components, be cautious not to block the drain hole of the frame.

5.2 Monofacial assembly mechanical installation

Module and bracket system connection can be realized by mounting holes, clamps or embedded systems. Installation shall follow the demonstration and suggestions below. If installation mode is different, please consult LONGi customer service personnel and obtain approval. Otherwise, modules may be damaged and limited warranty will be invalid.



5.2.1 Bolts Mounting

LONGi modules come standard with 8 mounting holes matching M8 bolts (marked by the blue dashed box in the figure below, according to the location distribution hereinafter referred to as inner four holes and outer four holes); 72 type and some 66 type modules have additional 4 mounting holes matching M6 bolts (marked by the red circle in the figure below, 400mm holes for short), which are used for matching with the tracking bracket system products from manufacturers such as NEXTracker. Apply bolts to fix modules on the bracket through mounting holes on the back-side frame. See details in Figure 4.

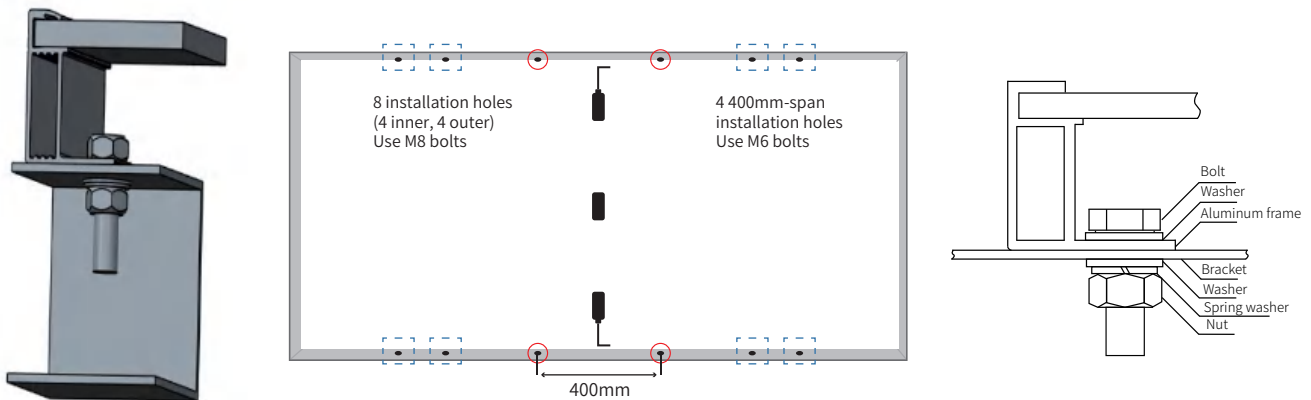

Figure4 Bolt Installation of Mono-facial Modules

Recommended accessories are as below :

Accessories	Model	Material	Note
Bolt	M8 (full thread recommended)	M6 (full thread recommended)	Accessories material selection should be based on application environment.
Washer	2pcs, thickness $\geq 1.5\text{mm}$ and outside diameters=16mm	2pcs, thickness $\geq 1.5\text{mm}$ and outside diameters =12-16mm	
Spring Washer	8	6	
Nut	M8	M6	

- Suggestion : (1) M8 bolt tightening torque range: 12-16 N•m; M6 bolt tightening torque range: 8-12 N•m;
 (2) When using LONGi 30mm (30H) height frame module, it is recommended to select $L \leq 20\text{mm}$ length fasteners. (If there is a special model, consult LONGi customer service personnel);

5.2.2 Clamp Mounting

The module can be mounted by a dedicated clamp, as shown in Figure 5.

Under no circumstances should the clamp touch the glass or deform the frame. The interface of the clamp to the front of the frame must be smooth and flat to prevent frame or other components from being damaged.

Make sure that these has no shadow caused by clamps.

The drain holes of module cannot be blocked by clamps.

For framed PV module, the clamp must maintain an overlap of 8-11 mm with the frame of the module (you can change the cross section of the clamp if the module is securely installed). For frameless PV module, the clamp must maintain an overlap of 15 mm at maximum with the module. The applied value of torque should refer to mechanical design standard and the bolt type customer is using, for example: M8: 14-18 N•m.

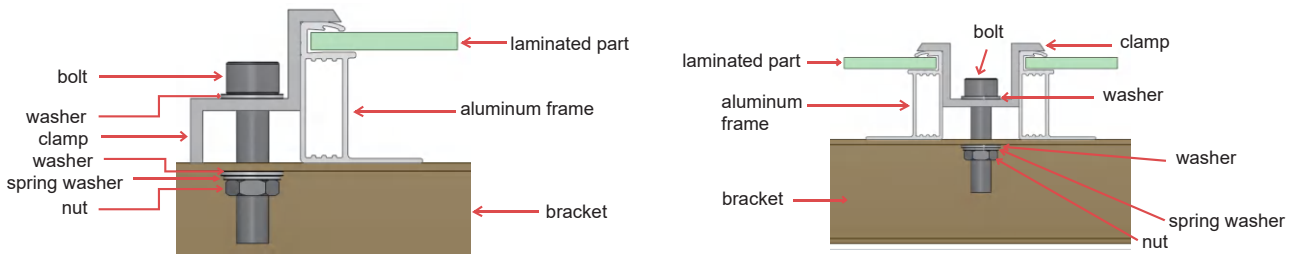

Figure 5 Clamp Installation of Monofacial Module

5.2.3 Installation and Mechanical Load of Monofacial Module

Mono-facial modules can be mounted by bolts or clamps. The mounting method and maximum test load are shown as follow (The unit of distance and length in the table below is millimeter (mm), and the unit of pressure is Pascal (pa)).

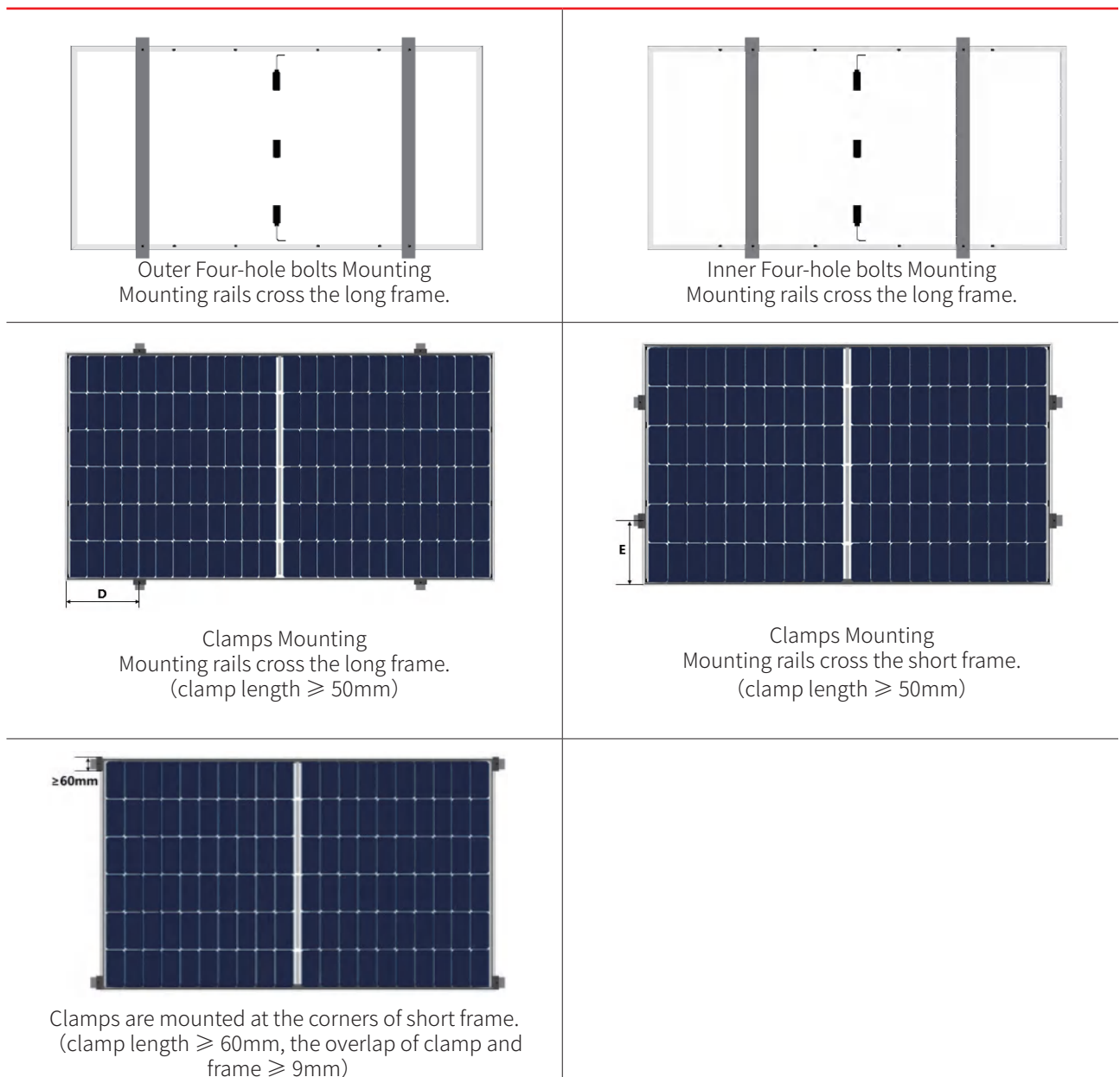

Figure 6 Monofacial Module Installation Annex

The maximum test load of framed mono-facial modules:

Installation Method Module Type		Bolts Mounting		Clamps Mounting					
		Mounting rails cross the long frame		Mounting rails cross the long frame				Mounting rails cross the short frame 150 ≤ E ≤ 250	Clamps are mounted at the corners of short frame
		Outer Four-hole	Inner Four-hole	1/4L-50 ≤ D ≤ 1/4L+50	250 ≤ D ≤ 350	300 ≤ D ≤ 450	400 ≤ D ≤ 500		
50/54/60/66-cell Framed Mono-facial Modules	LR4-50HPH-***M	±2400	+5400, -2400	+5400, -2400	/	/	/	±2400	/
	LR4-60HPH-***M	±2400	+5400, -2400	+5400, -2400	/	/	/	±2400	/
	LR4-60HPB-***M	±2400	+5400, -2400	+5400, -2400	/	/	/	±2400	/
	LR4-60HIH-***M	±2400	+5400, -2400	+5400, -2400	/	/	/	±2400	/
	LR4-60HIB-***M	±2400	+5400, -2400	+5400, -2400	/	/	/	±2400	/
	LR4-66HP-***M	+5400, -2400	±2400	/	/	+5400, -2400	/	±2400	/
	LR4-66HPH-***M	+5400, -2400	±2400	/	/	+5400, -2400	/	±2400	/
	LR4-66HIH-***M	+5400, -2400	±2400	/	/	+5400, -2400	/	±2400	/
	LR5-54HPH-***M	±2400	+5400, -2400	/	+5400, -2400	/	/	±2400	+2400/-1800
	LR5-54HPB-***M	±2400	+5400, -2400	/	+5400, -2400	/	/	±2400	+2400/-1800
	LR5-54HIH-***M	±2400	+5400, -2400	/	+5400, -2400	/	/	±2400	+2400/-1800
	LR5-54HIB-***M	±2400	+5400, -2400	/	+5400, -2400	/	/	±2400	+2400/-1800
	LR5-54HNB-***M	±2400	+5400, -2400	/	+5400, -2400	/	/	±2400	+2400/-1800
	LR5-54HTH-***M	±2400	+5400, -2400	/	+5400, -2400	/	/	±2400	+2400/-1800
	LR5-54HTB-***M	±2400	+5400, -2400	/	+5400, -2400	/	/	±2400	+2400/-1800
	LR5-66HPH-***M	+5400, -2400	±2400	/	/	+5400, -2400	/	±1800	±1600
LR5-66HIH-***M	+5400, -2400	-2400	/	/	+5400, -2400	/	±1800	±1600	
72-cell Framed Mono-facial Module	LR4-72HPH-***M	+5400, -2400	±2400	/	/	+5400, -2400	/	/	/
	LR4-72HIH-***M	+5400, -2400	±2400	/	/	+5400, -2400	/	/	/
	LR5-72HPH-***M	+5400, -2400	±2400	/	/	/	+5400, -2400	/	/
	LR5-72HIH-***M	+5400, -2400	±2400	/	/	/	+5400, -2400	/	/
	LR5-72HTH-***M	+5400, -2400	±2400	/	/	/	+5400, -2400	/	/



LONGi Mono-facial modules can be matched with the mainstream mounting systems in the industry. The test load of module with typical mounting systems are as follows. As for other special mounting systems which are not included in the table below, please consult LONGi customer service personnel.

Module Type	Compatible Support Brackets	Mounting Hardware	Test Load (pa)
LR4-72HPH-***M LR4-72HIH-***M	NEXTracker NX Horizon (1P)	Short Rail V2.3 4×bobtails (M6 head O.D. 16.8 mm) (400mm holes position)	±2400
		Short Rail V2.4 4×bobtails (M6 head O.D. 16.8 mm) (400mm holes position)	+1200, -2400
		Short Rail V2.4 + Reinforcement 4×bobtails (M6 head O.D. 16.8 mm) (400mm holes position)	±2400
	ATI DuraTrack™ HZ Tracking System (1P)	Hi-rise 300mm Clamp ^② Drawing No: 20822	±1500
		Hi-rise 400mm Clamp Drawing No: 20834	±1600
		600mm Clamp Drawing No: 20715	±2800
	Arctech Horizontal Single-axis Tracker SkySmart2 (2P)	3214mm rail + 900mm diagonal brace M8 bolt+M8 plain washer(O.D.=16mm) Drawing No: SZ0598640 + ZC9001740 990mm holes position	±2000
Soltec SF7 Single-Axis Tracker (2P)	2530mm rail M6 bolt+M6 plain washer (O.D.=18mm) Drawing No: SF7-MR-06-091 Rev.D00 400 + 1300mm holes position	+1200, -1800	
LR5-66HPH-***M LR5-66HIH-***M	NEXTracker NX Horizon (1P)	Short RailV2.4 + Reinforcement 4×bobtails (M6 head O.D. 16.8 mm) (400mm holes position)	±2400
LR5-72HPH-***M LR5-72HIH-***M LR5-72HTH-***M	NEXTracker NX Horizon (1P)	Short RailV2.4 + Reinforcement 4×bobtails (M6 head O.D. 16.8 mm) (400mm holes position)	±1800

① NEXTracker Short Rail V2.3 is at the stage of phase-out.

② LONGi recommends that the maximum torque value of bolts used at ATI Hi-rise 300mm should be 19 N•m.

The load information in this section comes from the sandbag pressure test results of LONGi or third-party certificate authorities. During the test, sandbags with the weight of ≤10Kg per each are used to evenly spread onto module surface.

5.3 Bifacial module Mechanical Installation

Modules and mounting system can be connected by bolts, clamps or embedded systems. Installation shall follow the demonstration and suggestions below. If installation mode is different, please consult LONGi and obtain approval.

Otherwise, modules could be damaged and quality warranty will be invalid.

5.3.1 Bolts Mounting

LONGi modules come standard with 8 mounting holes matching M8 bolts (marked by the blue dashed box in the figure below, according to the location distribution hereinafter referred to as inner four holes and outer four holes); 72 type and some 66 type modules have additional 4 mounting holes matching M6 bolts (marked by the red circle in the figure below, 400mm holes for short), which are used for matching tracking bracket system products from manufacturers such as NEXTracker. Apply bolts to fix modules on the bracket through mounting holes on the back frame. See details in Figure 7. A indicates the overlap range between module frame and bracket.

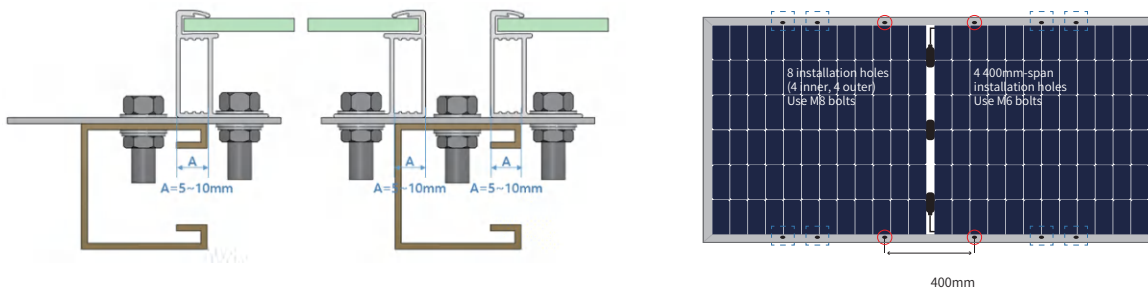

Figure 7 Bolt Installation of Bifacial Module

Recommended accessories are as below :

Accessories	Model	Material	Note
Bolt	M8 (full thread recommended)	M6 (full thread recommended)	Accessories material selection should be based on application environment.
Washer	2pcs, thickness \geq 1.5mm and outside diameters=16mm	2pcs, thickness \geq 1.5mm and outside diameters =12-16mm	
Spring Washer	8	6	
Nut	M8	M6	

- Suggestion : (1) M8 bolt tightening torque range: 12-16 N•m; M6 bolt tightening torque range: 8-12 N•m;
 (2) When using LONGi 30mm (30H) height frame module, it is recommended to select $L \leq 20$ mm length fasteners. (If there is a special model, consult LONGi customer service personnel);



5.3.2 Clamps Installation

Special clamps are used to install the modules, as shown in Figure 5. The clamp shall not be in touch with glass or deform module frame in any case. The interface of the clamp and frame front side shall be flat and smooth to prevent frame and module from being damaged.

Make sure that these has no shadow caused by clamps.

The drain holes of module cannot be blocked by clamps. For framed PV module, the clamp must overlap the module frame at least 8 mm (0.32 inch) but no more than 11 mm (0.43 inch). The cross section of clamp can be adjusted if the

module is securely fastened. For frameless PV module, the clamp must overlap the module frame at maximum 15 mm (0.59 inch). The applied value of torque should refer to mechanical design standard and the bolt type customer is using, for example: M8: 14-18 N•m.

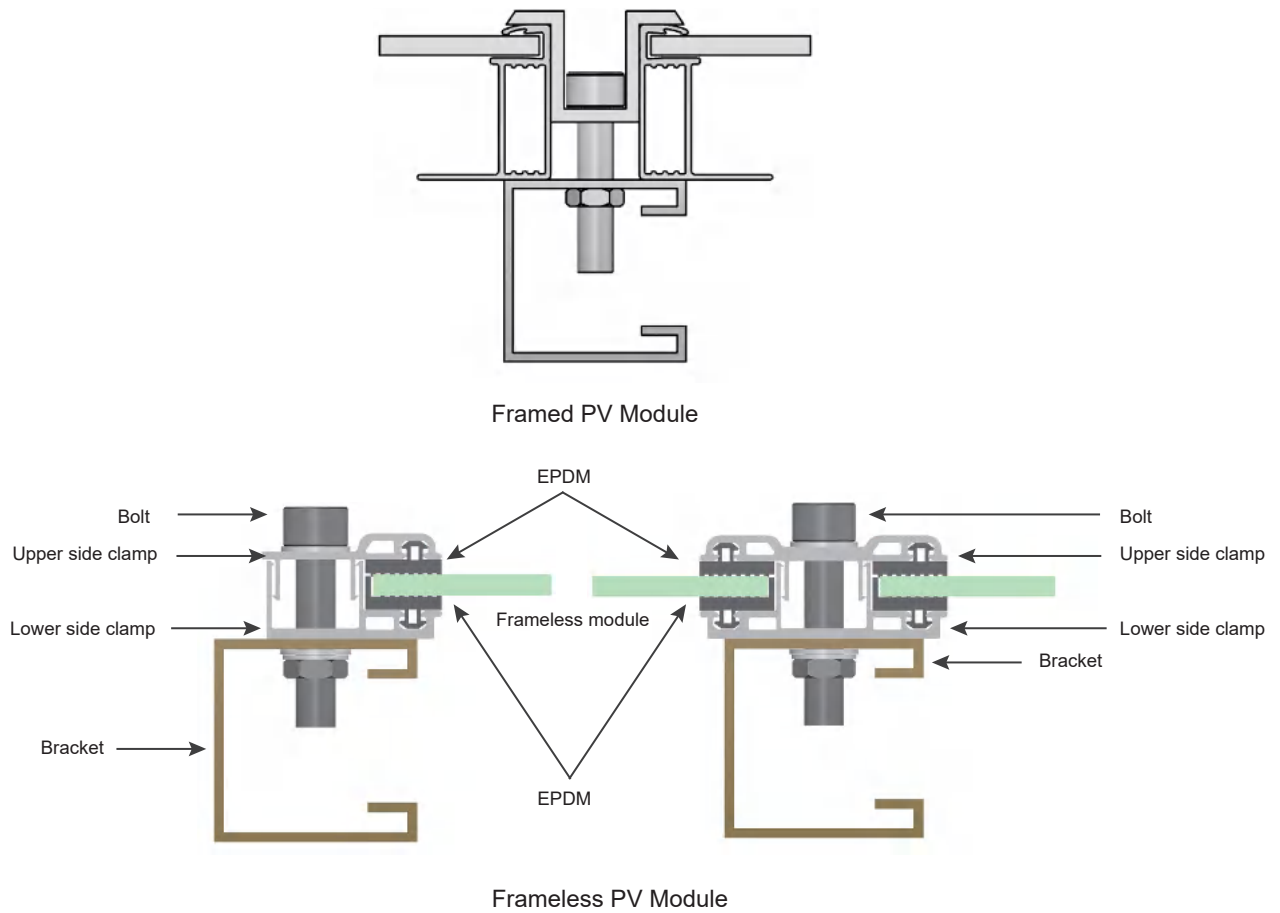
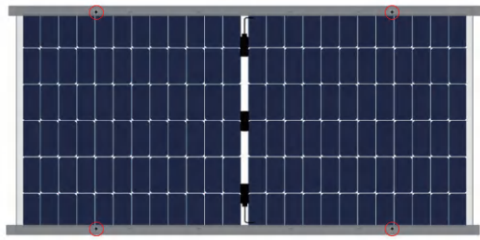

Figure 8 Clamp Installation of Bifacial Module



5.3.3 Installation and Mechanical Load of Bifacial Module

Bifacial modules can be mounted by bolts or clamps. The mounting method and maximum test load are shown as follow. (The unit of distance and length in the table below is millimeter (mm), and the unit of pressure is Pascal (pa)).



Outer Four-hole bolts Mounting
Mounting rails parallel the long frame.

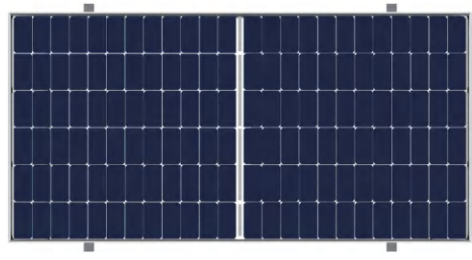

Outer Four-hole bolts Mounting
Mounting rails cross the long frame.

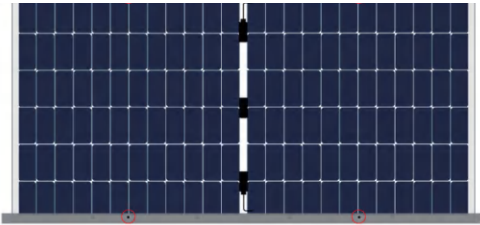

Inner Four-hole bolts Mounting
Mounting rails parallel the long frame.

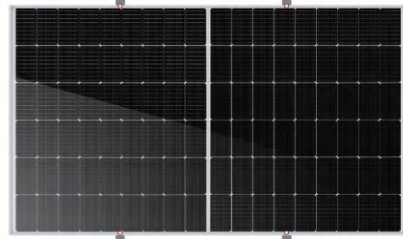

Inner Four-hole bolts Mounting
Mounting rails cross the long frame.

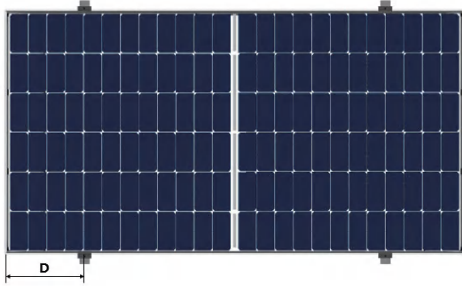

Installation of framed module with fixtures on long sides
(beam perpendicular to long sides)
(clamp length $\geq 40\text{mm}$)



Clamps Mounting
Mounting rails cross the long frame.
(clamp length $\geq 40\text{mm}$)

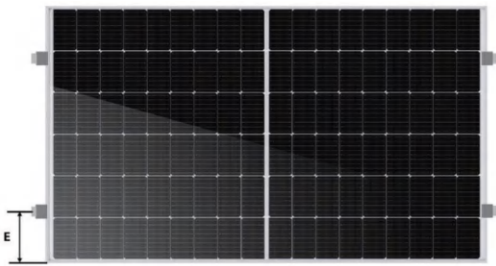

Clamps Mounting
Mounting rails cross the short frame.

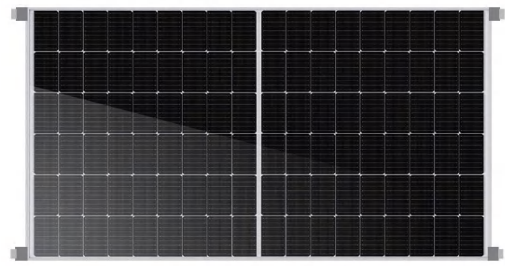

Clamps are mounted at the corners of short frame.

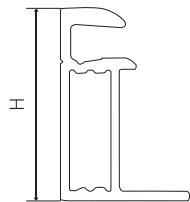

Aluminum Frame Height (H)

Figure 9 Bifacial Module Installation Annex

The maximum test load of framed Bifacial modules :

Module Type		Installation Method	Bolts Mounting		Clamps Mounting			
			Mounting rails cross the long frame		Mounting rails cross the long frame	Mounting rails cross the short frame		Clamps are mounted at the corners of short frame
			/		clamp length \geq 50 mm	the overlap of clamp and frame \geq 10 mm, clamp length \geq 50 mm		the overlap of clamp and frame \geq 10mm, clamp length \geq 50 mm
			Outer Four-hole	Inner Four-hole	250 \leq D \leq 350	150 \leq E \leq 250		/
54-cell Framed Bifacial Module	LR5-54HIBD-***M	\pm 2400	+ 5400-2400	+ 5400-2400	\pm 2400	+ 2400-1800		
	LR5-54HIBB-***M	\pm 2400	+ 5400-2400	+ 5400-2400	\pm 2400	+ 2400-1800		
	LR5-54HABD-***M	\pm 2400	+ 5400-2400	+ 5400-2400	\pm 2400	+ 2400-1800		
	LR5-54HABB-***M	\pm 2400	+ 5400-2400	+ 5400-2400	\pm 2400	+ 2400-1800		

Module Type		Installation Method	Bolts Mounting			Clamps Mounting				
			Mounting rails cross the long frame	Mounting rails parallel the long frame.		Mounting rails cross the long frame.		Mounting rails parallel the long frame.		
			Outer Four-hole	Outer Four-hole	Inner Four-hole	350 \leq D \leq 450	400 \leq D \leq 500	350 \leq D \leq 450	400 \leq D \leq 500	1/4L-50 \leq D \leq 1/4L+50
60/66-cell Framed Bifacial Module	LR4-60HBD-***M (30H)	/	\pm 2400	+ 5400, -2400	/	/	/	/	+ 5400, -2400	
	LR4-60HIBD-***M	/	\pm 2400	+ 5400, -2400	/	/	/	/	+ 5400, -2400	
	LR5-66HBD-***M	+ 5400, -2400	+ 3600, -2400	\pm 2400	+ 5400, -2400	/	+ 3600, -2400	/	/	
	LR5-66HIBD-***M	+ 5400, -2400	+ 3600, -2400	\pm 2400	+ 5400, -2400	/	+ 3600, -2400	/	/	
72-cell Framed Bifacial Module	LR4-72HBD-***M (35H)	/	+ 5400, -2400	\pm 2400	/	/	/	/	+ 5400, -2400	
	LR4-72HIBD-***M	/	+ 5400, -2400	\pm 2400	/	/	/	/	+ 5400, -2400	
	LR5-72HBD-***M	+ 5400, -2400	+ 3600, -2400	\pm 2400	/	+ 5400, -2400	/	+ 3600, -2400	/	
	LR5-72HIBD-***M	+ 5400, -2400	+ 3600, -2400	\pm 2400	/	+ 5400, -2400	/	+ 3600, -2400	/	
	LR5-72HND-***M	+ 5400, -2400	+ 3600, -2400	\pm 2400	/	+ 5400, -2400	/	+ 3600, -2400	/	
	LR5-72HTD-***M	+ 5400, -2400	+ 3600, -2400	\pm 2400	/	+ 5400, -2400	/	+ 3600, -2400	/	

LONGi bifacial modules can be matched with the mainstream bracket systems in the industry. The matching test load is as follows (for other bracket systems matching information which are not specified or included in the table below, please consult LONGi customer service personnel).

Module Type	Compatible Support Brackets	Mounting Hardware	Test Load (pa)
LR4-72HBD-***M LR4-72HIBD-***M	NEXTracker NX Horizon (1P)	Short Rail V2.4 4×bobtails (M6 head O.D. 16.8 mm) (400mm holes position)	±2400
	ATI DuraTrack™ HZ Tracking System (1P)	Hi-rise 300mm Clamp ^② Drawing No: 20822	±1500
		Hi-rise 400mm Clamp Drawing No: 20834	±1500
		600mm Clamp + Clamp Ear 80mm Drawing No: 20908	±2400
		600mm Clamp Drawing No: 20715	±2800
		850mm Clamp + Clamp Ear 80mm Drawing No: 20904	±3000
	Arctech Horizontal Single-axis Tracker SkySmart2 (2P)	3214mm rail + 900mm diagonal brace M8 bolt+M8 plain washer(O.D.=16mm) Drawing No: SZ0598640 + ZC9001740 990mm holes position	±2400
Soltec SF7 Single-Axis Tracker (2P)	2530mm rail M6 bolt+M6 plain washer (O.D.=18mm) Drawing No: SF7-MR-06-091 Rev.D00 400 + 1300mm holes position	±1800	
LR5-66HBD-***M LR5-66HIBD-***M	NEXTracker NX Horizon (1P)	Short Rail V2.4 4×bobtails (M6 head O.D. 16.8 mm) (400mm holes position)	±2400
LR5-72HBD-***M LR5-72HIBD-***M LR5-72HND-***M LR5-72HTD-***M	NEXTracker NX Horizon (1P)	Short RailV2.4 4×bobtails (M6 head O.D. 16.8 mm) (400mm holes position)	±2100
		Short RailV2.4 + 990m Supplement Rail 8× bobtails (M6 head O.D. 16.8 mm) 400+990mm holes position	±2400
	ATI DuraTrack™ HZ Tracking System (1P)	Hi-rise 300mm Clamp ^② Drawing No: 20822	±1200
		Hi-rise 400mm Clamp Drawing No: 20834	±1200
		600mm Clamp + Clamp Ear 80mm Drawing No: 20908	±1900
		850mm Clamp + Clamp Ear 80mm Drawing No: 20904	±2400
		1400mm Rail Drawing No: 20916	±3600
	Arctech Horizontal Single-axis Tracker Skyline (1P)	450mm Rail M6 bolt+M6 plain washer (O.D.=18mm) Drawing No: 300010141 400mm holes position	±1800
		1040mm Rail M8 bolt+M8 plain washer(O.D.=16mm) Drawing No: 300010142 990mm holes position	±2400
		1450mm Rail M8 bolt+M8 plain washer(O.D.=16mm) Drawing No: 300010143 1400mm holes position	±3600
	PV Hardware Omega-400 (1P)	428mm Rail M6 bolts+M6 washer(O.D.=18mm) Drawing No: MC_PR_Omega60x1_Oct_M6_S355_ZM310_400 400mm holes position	±1800
	Arctech Horizontal Single-axis TrackerSkysmart2 (2P) ^①	2786mm Rail 400mm holes: M6 bolt+M6 plain washer (O.D.=18mm) 990mm holes: M8 bolt+M8 plain washer (O.D.=16mm) Drawing No: SZ0598240 400+990mm holes position	+1800/-1600
		3376mm Rail + 900 斜撑 M8 bolt+M8 plain washer(O.D.=16mm) Drawing No: SZ0598340+ZC9001740 990mm holes position	+2200/-2000
3786mm Rail + 900 斜撑 M8 bolt+M8 plain washer(O.D.=16mm) Drawing No: SZ0598440+SZ0598440 1400mm holes position		+2600/-2200	
Soltec SF7 Single-Axis Tracker (2P) ^①	2832mm rail M6 bolt+M6 plain washer (O.D.=18mm) Drawing No: SF7-MR-06-064 Rev.P00 400 + 1400mm holes position	±1800	

① The modules are in upgrade, please consult customer service of LONGi solar before choosing trackers.

② LONGi recommends that the maximum torque value of bolts used at ATI Hi-rise 300mm should be 19 N·m.

The load information in this section comes from the sandbag pressure test results of LONGi or third-party certificate authorities. During the test, it is recommended that ≤10kg/sandbag is used to evenly spread the surface of the module.

6 Electrical installation

6.1 Electrical Performance

The electrical characteristics are within $\pm 3\%$ of the indicated values of I_{sc} , V_{oc} and P_{max} under STC (1000 W/m² Irradiance, a cell temperature of 25 °C and an AM1.5 spectrum).

When modules are in series connection, the string voltage is sum of every individual module in one string. When modules are in parallel connection, the current is sum of the individual module as shown in below figure 10. Modules with different electric performance models can not be connected in one string.

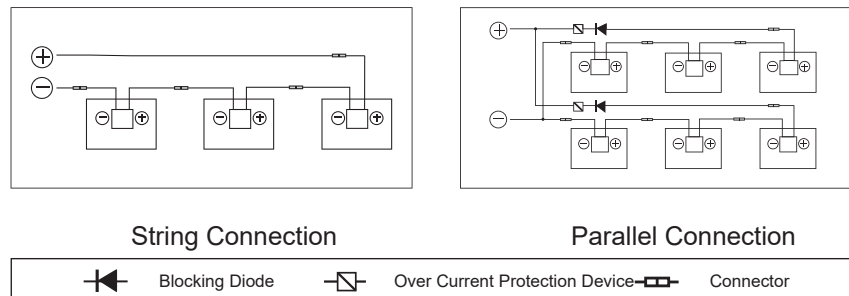

Figure 10 Series Connection and Parallel Connection Circuit Diagram

The maximum allowed quantity of modules in string connection shall be calculated according to relative regulations. The open circuit voltage value under the expected lowest temperature shall not exceed the maximum system voltage value allowed by modules and other values required by DC electric parts. (LONGi modules maximum system voltage is DC1000V/DC1500V---actually system voltage is designed based on the selected module and inverter model.)

The correction value of V_{OC} can be calculated by the following formula.

$$C_{V_{oc}} = 1 - \beta V_{oc} \times (25 - T)$$

T: The expected lowest temperature of the installation site.

β : V_{OC} temperature coefficient (% / °C) (Refer to module datasheet for further detail)

If there has reverse current exceeding the maximum fuse current flowing through the module, use overcurrent protection device with the same specifications to protect the module. If quantity of parallel connection is more than 2, there must be an overcurrent protection device on each string of module.



6.2 Cables and Wiring

PV Module's junction boxes with the IP67 protective level, can provide the safety protection for cable and wiring connection, also for contact protection of non-insulating electric parts. Each module has two individual wires connecting the junction box, one is negative pole and the other is positive pole. Two modules can be in series connection by inserting the positive pole at one end of wire of one module into the negative pole of the adjoining module.

According to local fire protection, building and electrical regulation, apply proper cable and connector; ensure the electrical and mechanical property of the cables (the cables should be put in a catheter with anti-UV aging properties, and if exposed to air, the cable itself should have anti-UV aging capability).

The installer can only use single-wire cable, $\geq 4\text{mm}^2$ (12 AWG), 90°C , with proper insulation capability to withstand the maximum open circuit voltage (such as EN50618 approval). Need to select appropriate wire specifications to reduce voltage drop.

LONGi requires that all wiring and electrical connections comply with the appropriate National Electrical Codes.

When cables are fixed on the bracket, avoid mechanical damaging cables or modules. Do not press cables by force. Adopt UV resistant cable ties and clamps to fix cables on the bracket. Though cables are UV resistant and water proof, it is still necessary to prevent cables from direct sun light and water immersion.

The minimum allowed bending radius of cables should be 43mm. (1.69 inch)

6.3 Connector

Please keep connectors clean and dry. Make sure connector caps are fastened before connection. Do not connect connectors under improper conditions of damp, dirty or other exceptional situations. Avoid connectors from direct sun light and water immersion or falling onto ground or roof.

Incorrect connection may lead to electric arc and electric shock. Please make sure that all electric connection is reliable. Make sure all connectors are fully locked.

Only connectors as the compatible model from same vendor can be mated together. Any doubt, please consult LONGi customer service personnel).

6.4 Bypass diode

LONGi solar module junction box contains bypass diode which is in parallel connection with the cell string. If hot spot occurred, the diode will come into operation to stop the main current from flowing through the hot spot cells in order to prevent module over-heated and performance loss. Notice, bypass diode is not the overcurrent protection device.

If the diode is definite or suspected to be defective, the installer or system maintenance supplier shall contact LONGi. Please do not try to open the module junction box on your own.



6.5 PID Protection and Inverter Compatibility

- ① PV modules may appear Potential Induced Degradation (PID) under high humidity, high temperature and high voltage condition. Modules may appear Potential Induced Degradation (PID) under the conditions below:
 - ◇ PV modules install under hot and humid weather condition.
 - ◇ PV modules installation site is under long-term humid environment such as water floating application.
- ② To reduce the risk of PID, on the modules DC connection site, it is recommended to connect the negative to ground. The PID protection measures on system level are recommended as follow
 - ◇ For isolated PV inverter, the negative of the PV modules DC connection side can be directly grounded.
 - ◇ For non-isolated PV inverter, isolated transformer is needed to be equipped before applying virtual grounding method for inverter.

7 Grounding

In design of modules, the anodized corrosion resistant aluminum alloy frame is applied for rigidity support. For safety consideration and to protect modules from lightning and electrostatic damage, the module frame must be grounded. The grounding device must be in full contact with inner side of the aluminum alloy and penetrate surface oxide film of the frame.

Do not drill additional grounding holes on module frame.

The grounding conductor or wire may be copper, copper alloy, or any other material acceptable for application as an electrical conductor per respective National Electrical Codes. The grounding conductor must then make a connection to ground with a suitable ground electrode.

There have grounding holes with the diameter of Ø4.2 mm at the edge location of module's back-side frame. The grounding hole on the frame is marked with typical grounding symbol (\equiv) according to IEC 61730-1 standard, which can only be used for grounding, not for module installation.

Grounding between modules shall be confirmed by qualified electricians and grounding devices shall be manufactured by qualified electric manufacturer. The copper core wire used for the grounding clamp is recommended to be 12 AWG. And copper wires cannot be pressed during installation in case of damaging.



The following is one of the recommended grounding methods of LONGi modules:

- ◆ Align grounding clamp to the frame mounting hole. Use grounding bolt to go through the grounding clamp and frame.
- ◆ Put the tooth side of the washer on the other side and fasten the nuts.
- ◆ Put grounding wires through the grounding clamp and grounding wire material and dimension shall meet requirements in local national and regional law and regulations.
- ◆ Fasten bolts of grounding wires and then installation is completed.

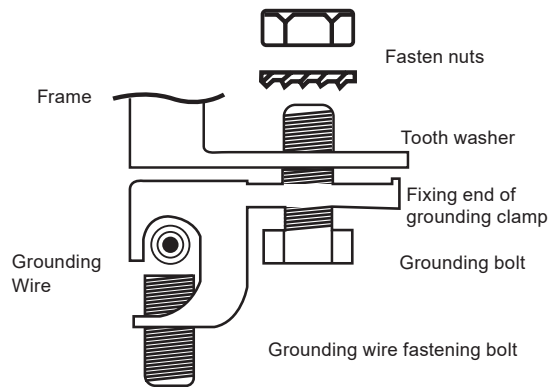

Figure 10 Bolt Grounding Method of PV Module

Mounting holes on modules that are not occupied can be used for installing grounding devices.

The third party grounding device can be used for grounding of LONGi modules but such grounding method shall be proved to be reliable. Grounding device shall be operated in line with stipulations of the manufacturer.

8 Operation and maintenance

It is the users' responsibility to carry out regular inspection and maintenance for modules, especially during the period of limited warranty. To inform the LONGi customer service personnel within two weeks when modules are found broken or other significant abnormality.

8.1 Cleaning

Accumulated contaminants on module surface glass will reduce the power output and lead to local hot spot, such as dust, industrial wasted water and birds' droppings. The severity of influence is determined by transparency of wastes. Small amounts of dust will affect the intensity and evenness of received solar irradiation but are not dangerous and power will not be reduced remarkably generally.



During operation of modules, there shall be no environmental factors to shade modules fully or partially. These environment factors including other modules, module mounting system, birds dwelling, dust, soil or plants. These will significantly reduce output power. LONGi suggests that the module surface should not be shadowed in any case.

Frequency of cleaning depends on dirt accumulation speed. In normal situations, rainwater will clean the module surface and reduce the cleaning frequency. It is suggested to use sponge dipped with clean water or soft cloth to wipe the glass surface. Do not use acid and alkaline detergents to clean modules. Do not use tool with rough surface to clean in any case.

In order to avoid potential risk of electrical shock or burn, LONGi suggests cleaning the modules during early morning or evening with low irradiance and low modules temperature especially for the hot regions.

In order to avoid potential risk of electrical shock, do not try to clean the modules with glass damage or expose wires.

8.2 Module Appearance Inspection

Check module cosmetic defects with naked eyes , especially:

- ◆ Module glass cracks.
- ◆ Corrosion at welding parts of the cell main grid (caused by moisture into the module due to damage of sealing materials during installation or transportation).
- ◆ Check whether there are traces of burning mark on the module back sheet.
- ◆ Check PV modules if any signs of aging including rodent damage, climate aging, connectors tightness, corrosion and grounding condition.
- ◆ Check if any sharp objects in contact with PV modules' surface
- ◆ Check if any obstacles shading the PV modules
- ◆ Check if any loose or damage screws between the modules and mounting system. If so, adjust and fix in time.

8.3 Inspection of Connectors and Cables

It is suggested to carry out the following preventive inspection twice a year:

- ◆ Check the tightness of the connectors and cables.
- ◆ Check if any crack or gap of silicone nearby the junction box.



9 Release and execution

This manual is implemented and managed by product management department of LONGi, who reserves the right to modify and revise this manual in any time without prior notice.



LONGi

LONGi Solar Technology Co, Ltd.

No.8369 Shangyuan Road, Xi'an Economic & Technological
Development Zone

www.longi.com